

REQUIRED CONTAMINATION CLASS	ISO 4406 class 20/18/15
OPERATING TEMPERATURE RANGE	-20° to +90°C

INLET	DIRECTION
A	RIGHT
B	LEFT

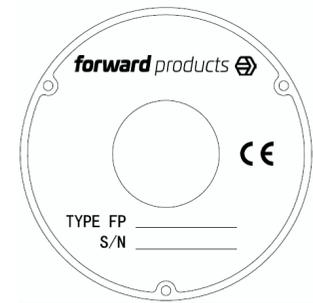
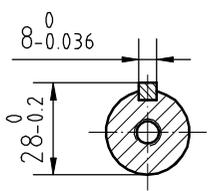
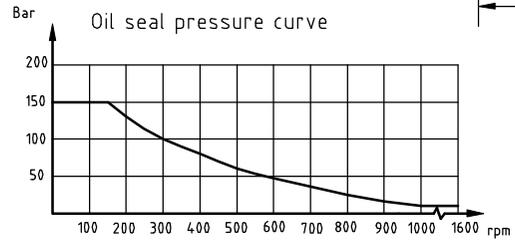
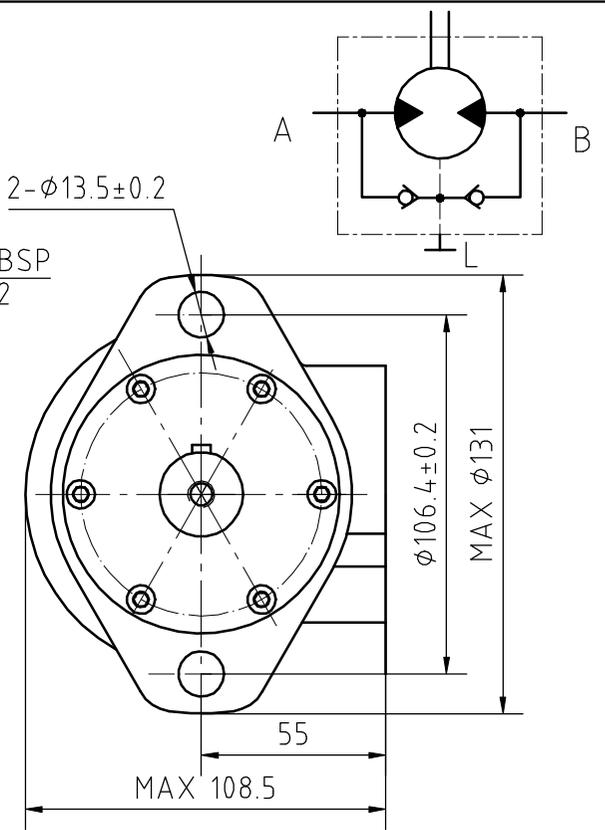
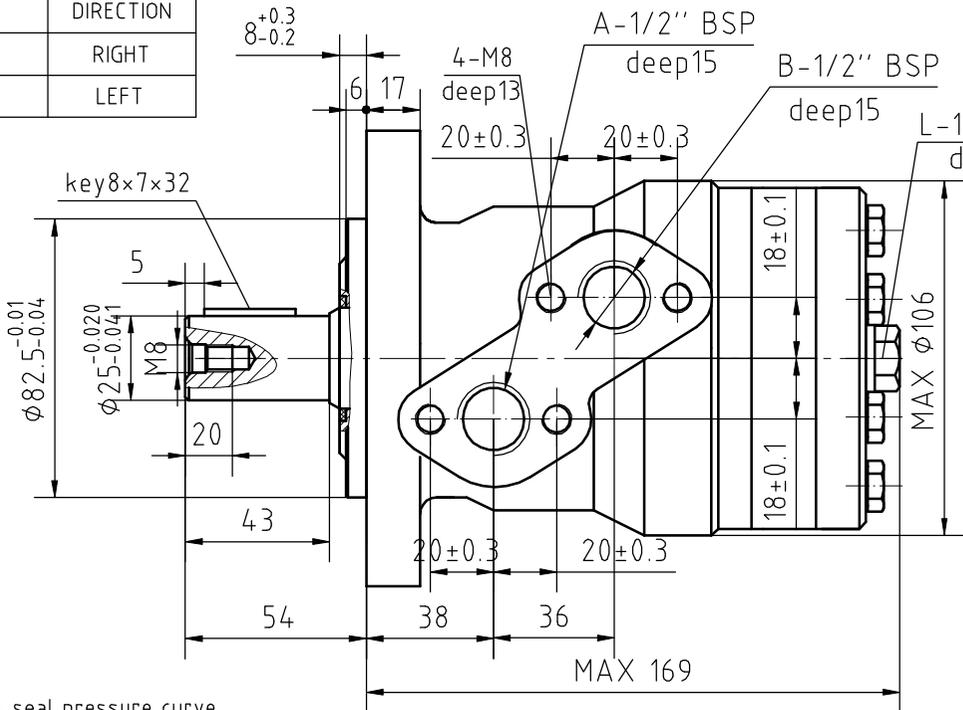

PRESSURE(bar)		
CONTINUOUS	INTERMITTENT	PEAK
175	200	220
Type:Geroller		

Max allowed back-pressure or drain pressure: 80bar
 Max allowed torque :378Nm
 Max speed: 370rpm
 PAINTING COLOUR:BLACK
 PAINTING THICKNESS RANGE: 0.04mm-0.06mm
 SHAFT AND FRONT HOUSING: MAGNESIUM PHOSPHATED

forward products	Date 06.03.2019
Nom.Displacement 160cc/rmp	
FP-MR160-2H-CY25-01	